

## TERRASYS Dielenbefestigung unsichtbar [Holz-UK]

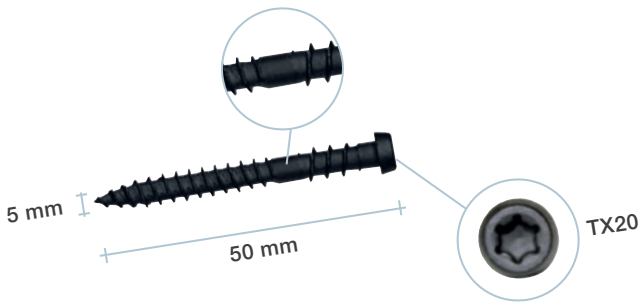

Dazugehörige Spezialschraube für unsichtbaren Abstandhalter:  
Im SET „Dielenbefestigung unsichtbar“ mitenthalten.

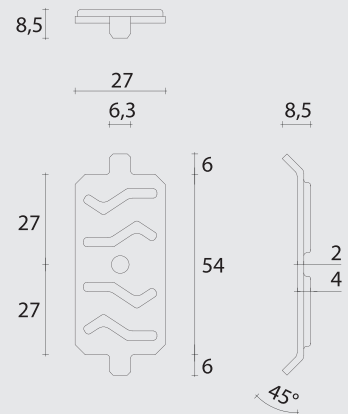



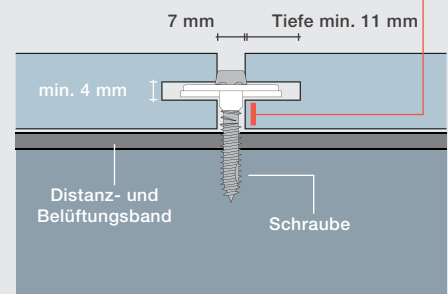









Durch unser System „Dielenbefestigung unsichtbar“ ist der **Abstand** der **Nut** zur **Dielenunterkante** extrem variabel.

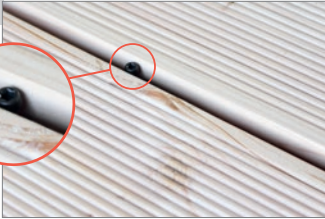

Art.-Nr.	Artikelbezeichnung	Inhalt
505 11 055	TERRASYS Dielenbefestigung unsichtbar* (inkl. Schrauben) 50 unsichtbare Abstandhalter + 50 Schrauben	50 St.
505 11 205	TERRASYS Dielenbefestigung unsichtbar* (inkl. Schrauben) 200 unsichtbare Abstandhalter + 200 Schrauben	200 St.
101 950 50	TERRASYS Schraube für unsichtbaren Abstandhalter	100 St.
505 11 100	TERRASYS Distanz- und Belüftungsband (10 m; 10 x 6 mm)	1 St.
820 050 020	Bits Torx TX 20 (20 x 50 mm; ¼"-Sechskant)	1 St.
411 001	Bohrer mit Senker und Tiefenanschlag (ø 3,2 mm)	1 St.

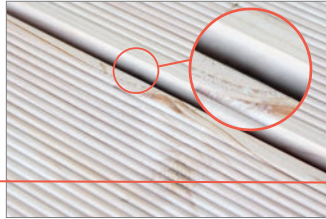
**TERRASys** Dielenbefestigung unsichtbar

Montageanleitung:

<b>1</b>				Schraube leicht anschrauben.
<b>4</b>				Alternativ bietet sich als ideale „Verlegehilfe“ unser „beko Spanngurt“ an.
<b>7</b>				a) Nächste Reihe unsichtbare Abstandhalter leicht anschrauben (s. Abb. 3). b) Vorherige Schraubenreihe vollständig festziehen.
<b>10</b>				Befestigung der Abschlussdielen: a) 45°-Bohrung mit Senker. b) Die Abschlussdielen mit einer Schraube fixieren.

Berechnungsformel Dielenbefestigung unsichtbar:

$$\text{Stück pro m}^2 = 1\text{m}^2 / Z / (B + F)$$

Z = Zwischenabstand Unterkonstruktion in m  
B = Brettbreite in m  
F = Fugenbreite in m (0,007 m)

